

# Silicon – Diode Array

## **FSA2502M**

16 Diode Array

60V/350mA

# DATASHEET

OEM – Fairchild

Source: Fairchild Databook 1978

# FSA2500M • FSA2501M • FSA2501P • FSA2502M

## PLANAR AIR-ISOLATED MONOLITHIC DIODE ARRAYS\*

- C... 5.0 pF (MAX)
- V<sub>F</sub>... 15 mV (MAX) @ 10 mA

### ABSOLUTE MAXIMUM RATINGS (Note 1)

#### Temperatures

Storage Temperature Range (M Suffix)	-55° C to +200° C
(P Suffix)	-55° C to +150° C
Maximum Junction Operating Temperature	+150° C
Lead Temperature	+260° C

#### Power Dissipation (Note 2)

Maximum Dissipation per Junction at 25° C Ambient	400 mW
Maximum Dissipation per Package at 25° C Ambient	650 mW
Linear Derating Factor (from 25° C) Junction	3.2 mW/° C
Package	5.2 mW/° C

#### Maximum Voltage and Currents

WIV	Working Inverse Voltage	50 V
I <sub>F</sub>	Continuous Forward Current	350 mA
i <sub>F</sub> (surge)	Peak Forward Surge Current	
	Pulse Width = 1.0 s	1.0 A
	Pulse width = 1.0 μs	2.0 A

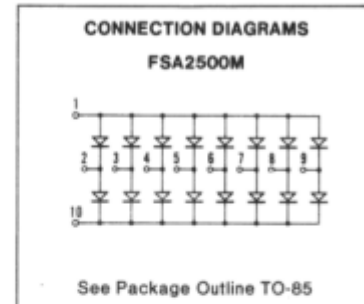

### ELECTRICAL CHARACTERISTICS (25° C Ambient Temperature unless otherwise noted)

SYMBOL	CHARACTERISTIC	MIN	MAX	UNITS	TEST CONDITIONS
BV	Breakdown Voltage	60		V	I <sub>R</sub> = 10 μA
V <sub>F</sub>	Forward Voltage (Note 3)		1.0 1.1 1.5	V	I <sub>F</sub> = 100 mA I <sub>F</sub> = 200 mA I <sub>F</sub> = 500 mA
ΔV <sub>F</sub>	Forward Voltage Match (Note 6)		15	mV	I <sub>F</sub> = 10 mA
I <sub>R</sub>	Reverse Current (Note 4)		100 200	nA μA	V <sub>R</sub> = 50 V V <sub>R</sub> = 50 V, T <sub>A</sub> = 125° C
C	Capacitance (Note 5)		5.0	pF	V <sub>R</sub> = 0, f = 1.0 MHz
t <sub>fr</sub>	Forward Recovery Time (Note 6)		40	ns	I <sub>F</sub> = 500 mA
t <sub>rr</sub>	Reverse Recovery Time (Note 6)		10 50	ns	I <sub>F</sub> = I <sub>F</sub> = 10 mA to 200 mA R <sub>L</sub> = 100 Ω, I <sub>rr</sub> = 0.1 I <sub>R</sub> I <sub>F</sub> = 500 mA, I <sub>F</sub> = 50 mA R <sub>L</sub> = 100 Ω, I <sub>rr</sub> = 5.0 mA

#### NOTES:

1. These ratings are limiting values above which life or satisfactory performance may be impaired.
2. These are steady state limits. The factory should be consulted on applications involving pulsed or low duty-cycle operation.
3. V<sub>F</sub> is measured using an 8 ms pulse.
4. See test circuits (Note 6) for measurement of reverse current of an individual diode.
5. The capacitance is measured from pin-to-pin across any one of the diodes. The interaction of other diodes is therefore included in the measured value.
6. For product family characteristic curves and test circuits refer to Chapter 4, D15.

\* 16-DIODE CORE DRIVER MATRIX

FAIRCHILD • DIODE ARRAYS

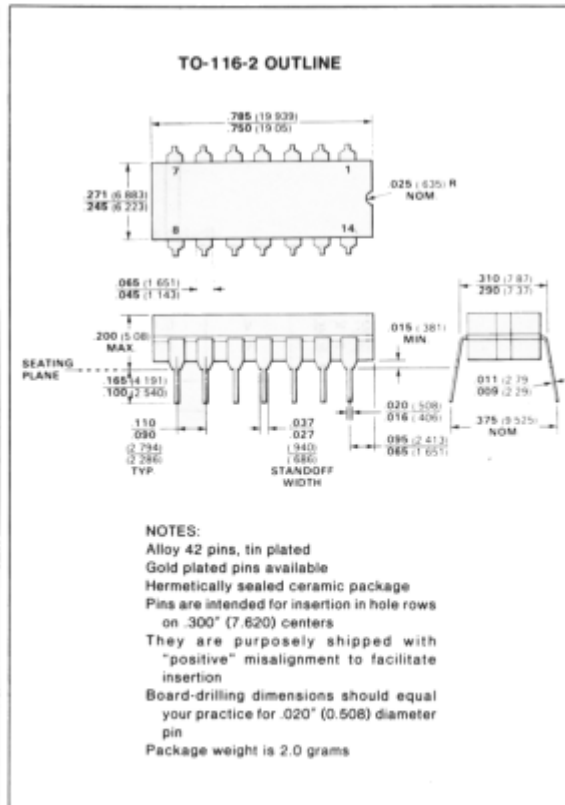
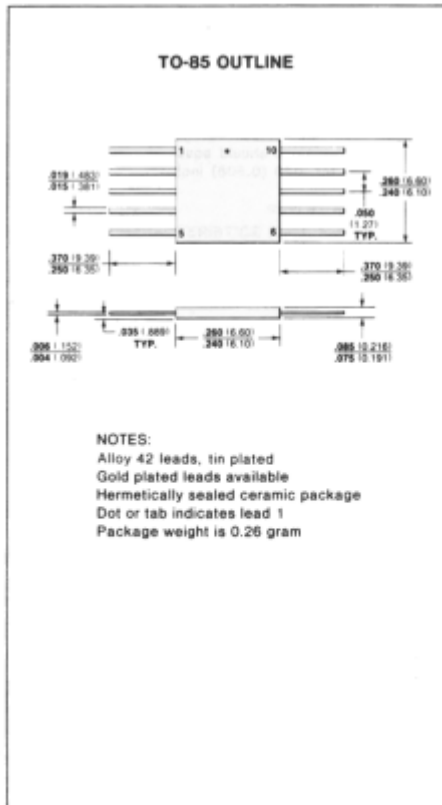
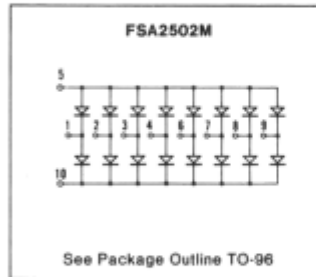
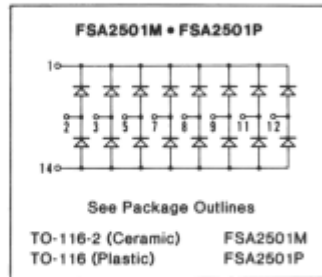

FAIRCHILD • DIODE ARRAYS

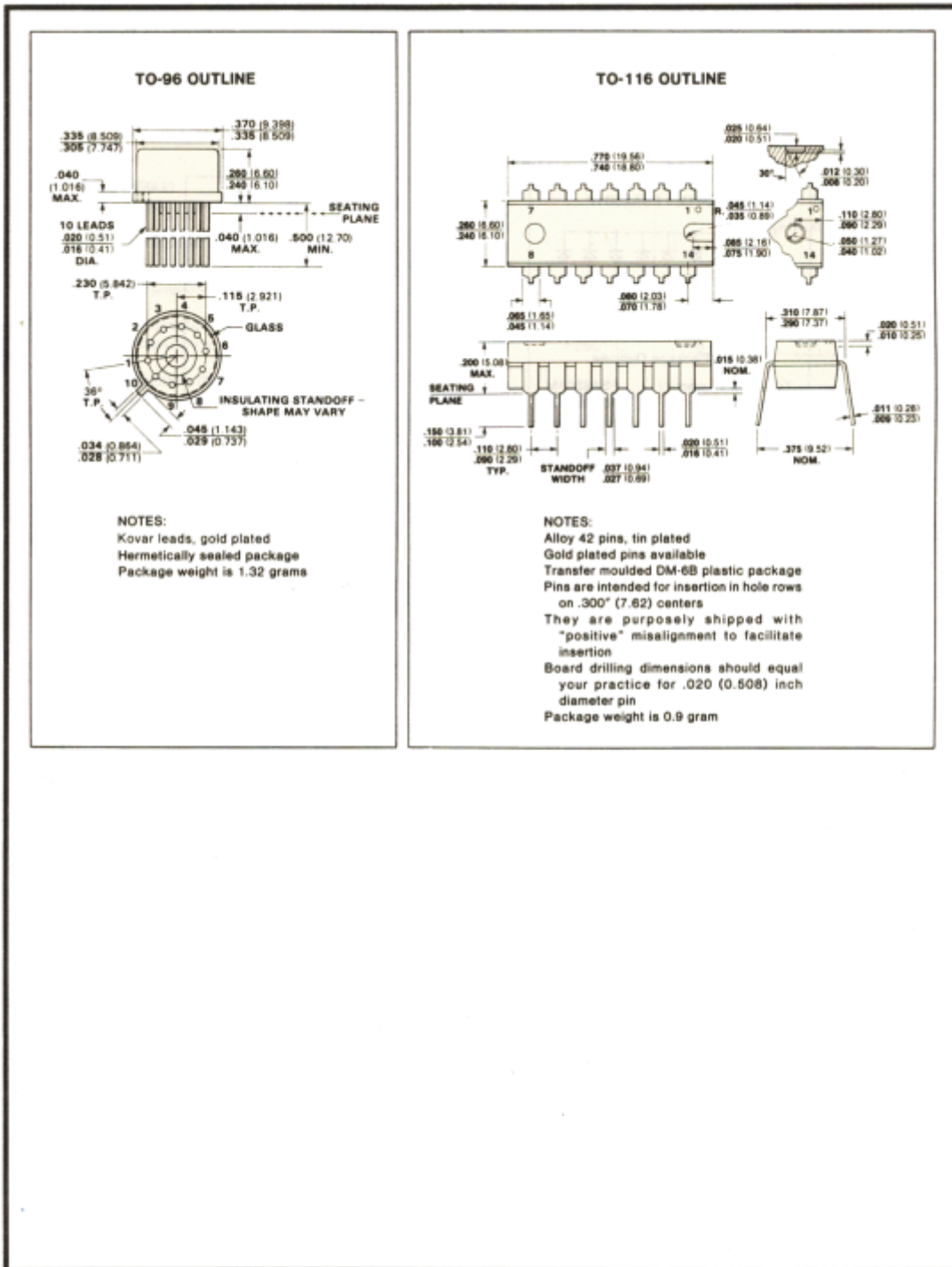

**CURVE SET NUMBER D15**  
**AIR-ISOLATED MONOLITHIC DIODE ARRAY**

**TYPICAL ELECTRICAL CHARACTERISTIC CURVES**  
 AT 25°C AMBIENT TEMPERATURE UNLESS OTHERWISE NOTED

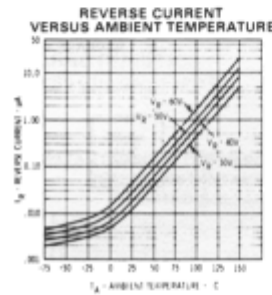
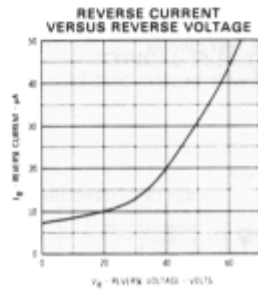
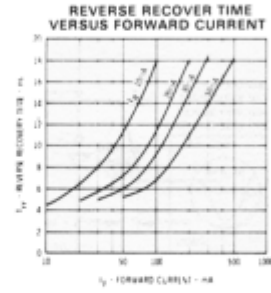
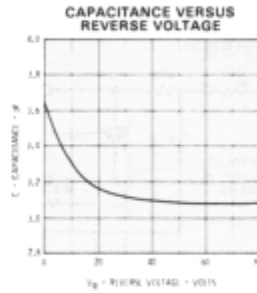
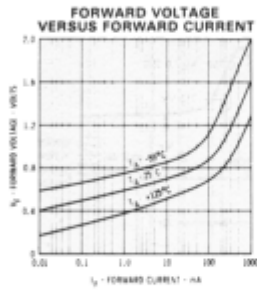

**TEST CIRCUITS**

To measure reverse current of an individual diode, the following test circuits are used:

**COMMON CATHODE DIODES**

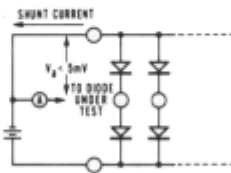

**COMMON ANODE DIODES**

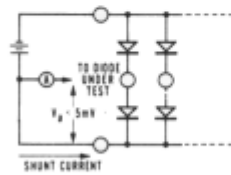

**CURVE SET NUMBER D15**  
**AIR-ISOLATED MONOLITHIC DIODE ARRAY**

**TEST CIRCUITS**

Test requirement for  $V_{FM}$  and  $t_r$  is as shown below; all leads should be as short as possible.

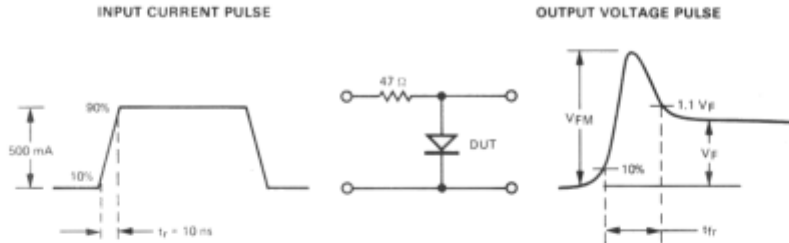

**$t_{rr}$  - REVERSE RECOVERY TIME TEST CIRCUIT**

$$I_f = I_r, I_{rr} = 0.1 I_r$$

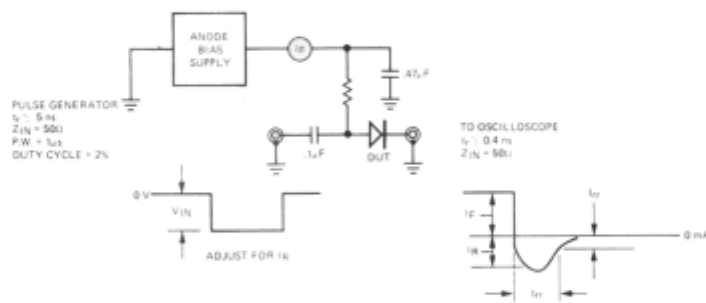

**$\Delta V_F$  BRIDGE MATCHING CIRCUIT**

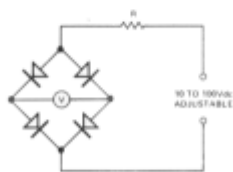

**$\Delta I_R$  BRIDGE MATCHING CIRCUIT**

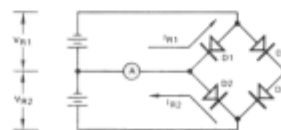

**NOTES:**

1. R Varies depending on the current range. For the most often used current ranges, R is as follows:

Current Range (amperes)	R (ohms)
$10^{-5}$ to $10^{-4}$	$10^6$
$10^{-4}$ to $10^{-3}$	$10^5$
$10^{-3}$ to $10^{-2}$	$10^4$
or $10^{-n}$ to $10^{-n+1}$	$10^{n+1}$

2. V indicates mismatch of assembly.

**NOTES:**

- $V_{R2} = V_{R1} \pm 1\%$ .
- $I_{R2} - I_{R1} = \Delta I_R$  (difference in  $I_R$  between diodes D1 & D2). To measure diodes D3 & D4, reverse cathode-anode terminal connections.
- A is a center reading pico ammeter.  $\Delta I_R$  indicated directly on A.