

Schottky Diode

10BQ060

60V / 1A

DATASHEET

OEM – International Rectifier

Source: International Rectifier Databook 1995

International Rectifier

PD - 2.438A

10BQ060

SCHOTTKY RECTIFIER

1 Amp

Major Ratings and Characteristics

Characteristics	10BQ060	Units
$I_{F(AV)}$ Rectangular waveform	1.0	A
V_{RRM}	60	V
I_{FSM} @ $t_p = 5\mu s$ sine	700	A
V_f @ 1.0Apk, $T_J = 125^\circ C$	0.54	V
T_J	-55 to 150	$^\circ C$

Description / Features

The 10BQ060 surface-mount Schottky rectifier has been designed for applications requiring very low forward drop and small foot prints on PC boards. Typical applications are in disk drives, switching power supplies, converters, free-wheeling diodes, battery charging and reverse battery protection.

- Small footprint, surface mountable
- Very low forward voltage drop
- High frequency operation
- Guard ring for enhanced ruggedness and long-term reliability

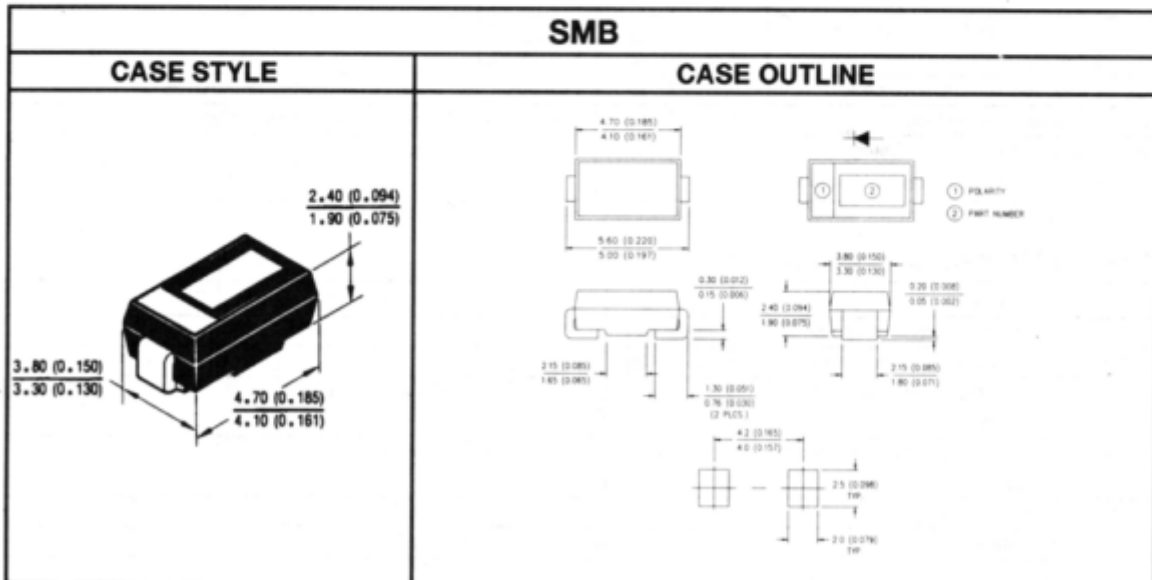

10BQ060

Voltage Ratings

Part number	10BQ060
V_R Max. DC Reverse Voltage (V)	60
V_{RWM} Max. Working Peak Reverse Voltage (V)	

Absolute Maximum Ratings

Parameters	10BQ	Units	Conditions
$I_{F(AV)}$ Max. Average Forward Current See Fig. 5	1.0	A	50% duty cycle @ $T_C = 103^\circ\text{C}$, rectangular waveform
I_{FSM} Max. Peak One Cycle Non - Repetitive Surge Current — see Fig. 7	700	A	Following any rated load condition and with rated V_{RWM} applied.
	42		
E_{AS} Non - Repetitive Avalanche Energy	11	mJ	$T_J = 25^\circ\text{C}$, $I_{AS} = 1.0\text{A}$, $L = 4.0\text{mH}$
I_{AR} Repetitive Avalanche Current	1.0	A	Current decaying linearly to zero in $1\mu\text{sec}$ Frequency limited by T_J max. $V_A = 1.5 \times V_R$ typical

Electrical Specifications

Parameters	10BQ	Units	Conditions
V_{FM} Max. Forward Voltage Drop See Fig. 1 Φ	0.57	V	@ 1.0A
	0.73	V	@ 2.0A
	0.54	V	@ 1.0A
	0.66	V	@ 2.0A
I_{RM} Max. Reverse Leakage Current Φ See Fig. 2	0.1	mA	$T_J = 25^\circ\text{C}$
	5.0	mA	$T_J = 125^\circ\text{C}$
C_T Max. Junction Capacitance	62	pF	$V_R = 5V_{DC}$, (test signal range 100kHz to 1MHz) 25°C
L_S Typical Series Inductance	2.0	nH	Measured lead to lead 5mm from package body
dv/dt Max. Voltage Rate of Change (Rated V_R)	10,000	V/ μs	

Thermal-Mechanical Specifications

Parameters	10BQ	Units	Conditions
T_J Max. Junction Temperature Range	-55 to 150	$^\circ\text{C}$	
T_{STG} Max. Storage Temperature Range	-55 to 150	$^\circ\text{C}$	
$R_{\theta JA}$ Max. Thermal Resistance, Junction to Ambient	140	$^\circ\text{C}/\text{W}$	DC operation — See Fig. 4
$R_{\theta JL}$ Max. Thermal Resistance, Junction to Lead $\text{\textcircled{2}}$	36	$^\circ\text{C}/\text{W}$	DC operation
wt Approximate Weight	0.10	g	
Case Style	SMB		Similar to DO-214AA

Φ Pulse Width < 300 μs , Duty Cycle < 2%

$\text{\textcircled{2}}$ Mounted 1 inch square PCB, thermal probe connected to lead 2mm from package

10BQ060

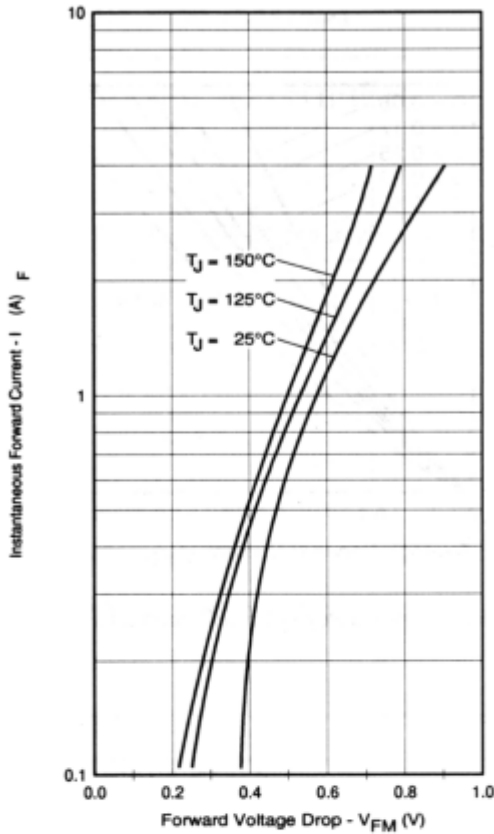

Fig. 1 Max. Forward Voltage Drop Characteristics

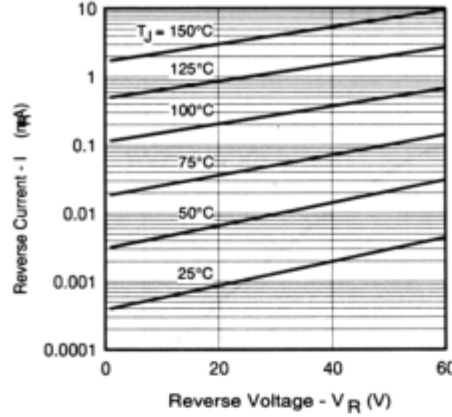

Fig. 2 Typical Values of Reverse Current Vs. Reverse Voltage

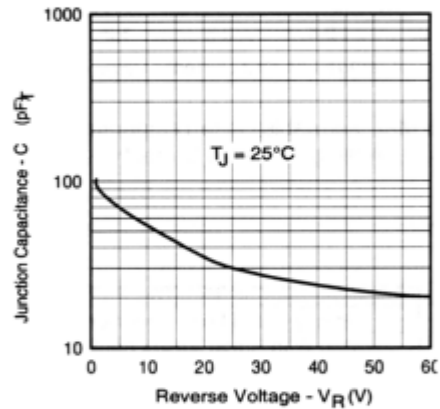

Fig. 3 Typical Junction Capacitance Vs. Reverse Voltage

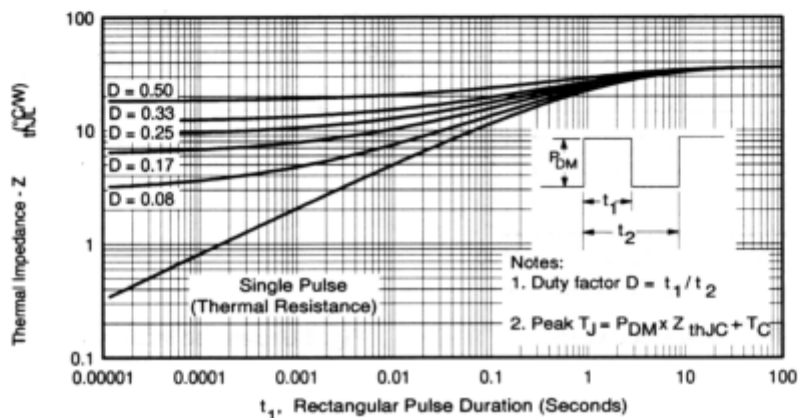

Fig. 4 Max. Thermal Impedance Z_{thJL} Characteristics

10BQ060

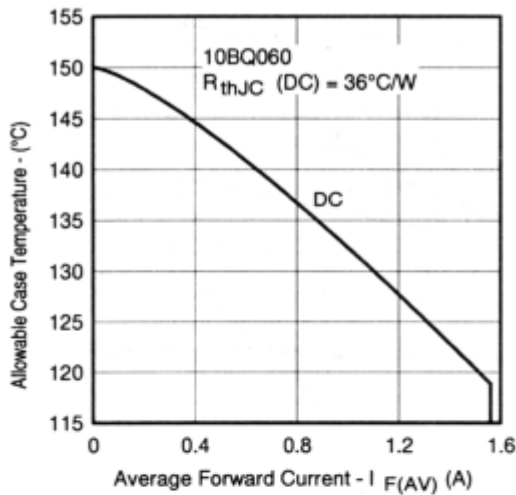

Fig. 5 Max. Allowable Case Temperature Vs. Average Forward Current

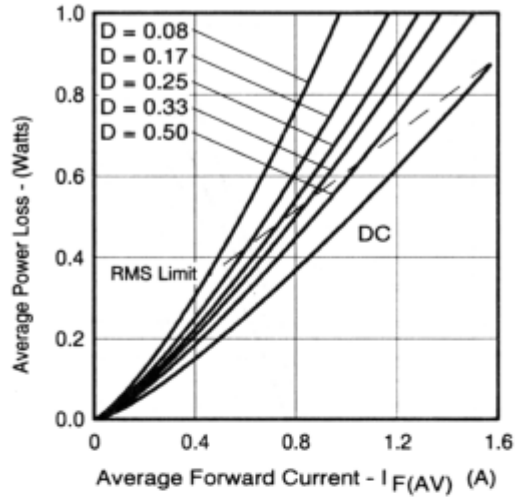

Fig. 6 Forward Power Loss Characteristics

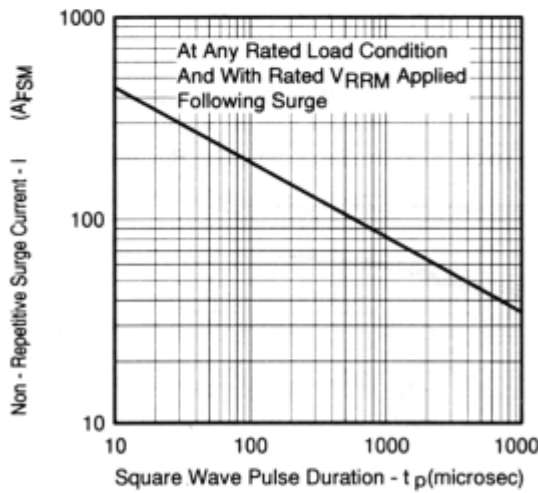

Fig.7 Max. Non-Repetitive Surge Current

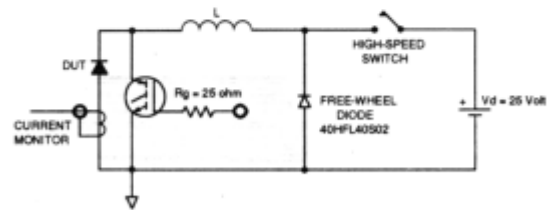

Fig. 8 Unclamped Inductive Test Circuit

Refer to the Appendix Section for the following:

Appendix D: Tape and Reel Information — See page 338.