

Silicon Diode

BYM56C

600V/3.5A

DATASHEET

OEM – Philips

Source: Philips Databook 1999

Controlled avalanche rectifiers

BYM56 series

FEATURES

- Glass passivated
- High maximum operating temperature
- Low leakage current
- Excellent stability
- Guaranteed avalanche energy absorption capability
- Available in ammo-pack
- Also available with preformed leads for easy insertion.

DESCRIPTION

Rugged glass package, using a high temperature alloyed construction.

This package is hermetically sealed and fatigue free as coefficients of expansion of all used parts are matched.

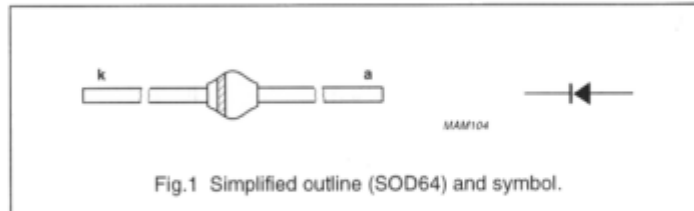

Fig.1 Simplified outline (SOD64) and symbol.

LIMITING VALUES

In accordance with the Absolute Maximum Rating System (IEC 134).

SYMBOL	PARAMETER	CONDITIONS	MIN.	MAX.	UNIT
V_{RRM}	repetitive peak reverse voltage				
	BYM56A		–	200	V
	BYM56B		–	400	V
	BYM56C		–	600	V
	BYM56D		–	800	V
	BYM56E		–	1000	V
V_{RWM}	crest working reverse voltage				
	BYM56A		–	200	V
	BYM56B		–	400	V
	BYM56C		–	600	V
	BYM56D		–	800	V
	BYM56E		–	1000	V
V_R	continuous reverse voltage				
	BYM56A		–	200	V
	BYM56B		–	400	V
	BYM56C		–	600	V
	BYM56D		–	800	V
	BYM56E		–	1000	V
$I_{F(AV)}$	average forward current	$T_{ip} = 60\text{ °C}$; lead length = 10 mm; averaged over any 20 ms period; see Figs 2 and 4	–	3.5	A
		$T_{amb} = 65\text{ °C}$; PCB mounting (see Fig.9); averaged over any 20 ms period; see Figs 3 and 4	–	1.4	A
I_{FSM}	non-repetitive peak forward current	$t = 10\text{ ms}$ half sinewave; $T_j = T_{jmax}$ prior to surge; $V_R = V_{RRMmax}$	–	80	A

Controlled avalanche rectifiers

BYM56 series

SYMBOL	PARAMETER	CONDITIONS	MIN.	MAX.	UNIT
E_{RSM}	non-repetitive peak reverse avalanche energy	$L = 120 \text{ mH}$; $T_j = T_{j,max}$ prior to surge; inductive load switched off	–	20	mJ
T_{stg}	storage temperature		–65	+175	°C
T_j	junction temperature	see Fig.5	–65	+175	°C

ELECTRICAL CHARACTERISTICS

$T_j = 25 \text{ °C}$; unless otherwise specified.

SYMBOL	PARAMETER	CONDITIONS	MIN.	TYP.	MAX.	UNIT	
V_F	forward voltage	$I_F = 3 \text{ A}$; $T_j = T_{j,max}$; see Fig.6	–	–	0.95	V	
		$I_F = 3 \text{ A}$; see Fig.6	–	–	1.15	V	
$V_{(BR)R}$	reverse avalanche breakdown voltage	$I_R = 0.1 \text{ mA}$					
			BYM56A	225	–	–	V
			BYM56B	450	–	–	V
			BYM56C	650	–	–	V
			BYM56D	900	–	–	V
I_R	reverse current	$V_R = V_{RRM,max}$; see Fig.7	–	–	1	µA	
		$V_R = V_{RRM,max}$; $T_j = 165 \text{ °C}$; see Fig.7	–	–	150	µA	
t_{rr}	reverse recovery time	when switched from $I_F = 0.5 \text{ A}$ to $I_R = 1 \text{ A}$; measured at $I_R = 0.25 \text{ A}$; see Fig.10	–	3	–	µs	
C_d	diode capacitance	$V_R = 0 \text{ V}$; $f = 1 \text{ MHz}$; see Fig.8	–	90	–	pF	

THERMAL CHARACTERISTICS

SYMBOL	PARAMETER	CONDITIONS	VALUE	UNIT
$R_{th(j-tp)}$	thermal resistance from junction to tie-point	lead length = 10 mm	25	K/W
$R_{th(j-a)}$	thermal resistance from junction to ambient	note 1	75	K/W

Note

- Device mounted on epoxy-glass printed-circuit board, 1.5 mm thick; thickness of copper $\geq 40 \text{ µm}$, see Fig.9. For more information please refer to the "General Part of Handbook SC01".

Controlled avalanche rectifiers

BYM56 series

GRAPHICAL DATA

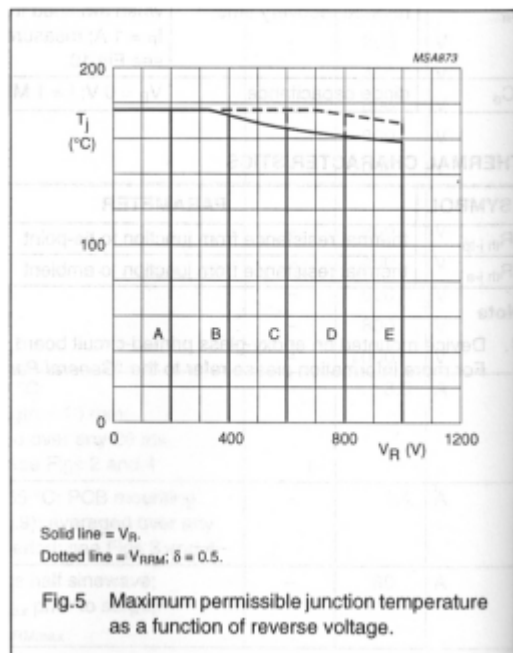
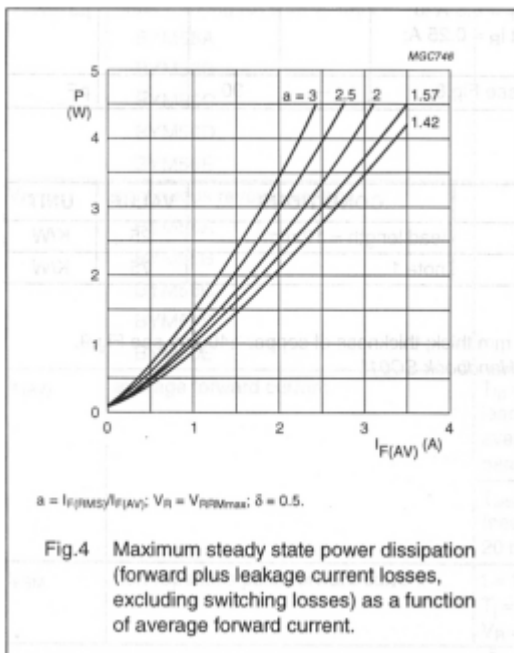
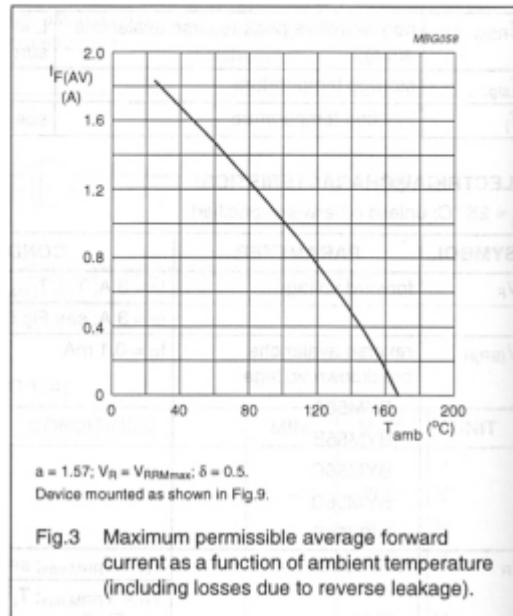
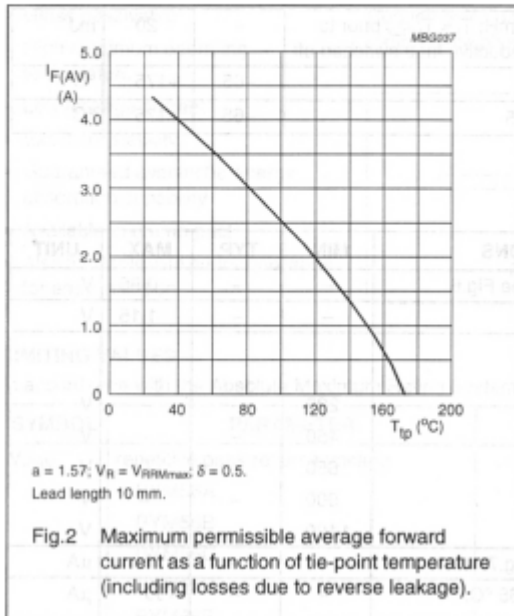

Controlled avalanche rectifiers

BYM56 series

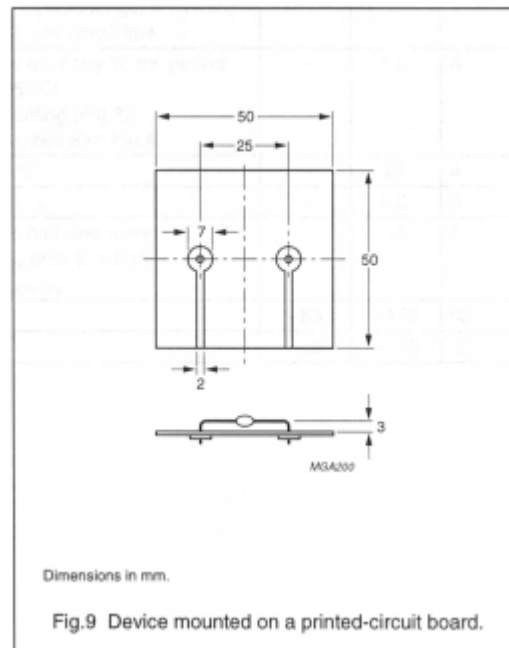
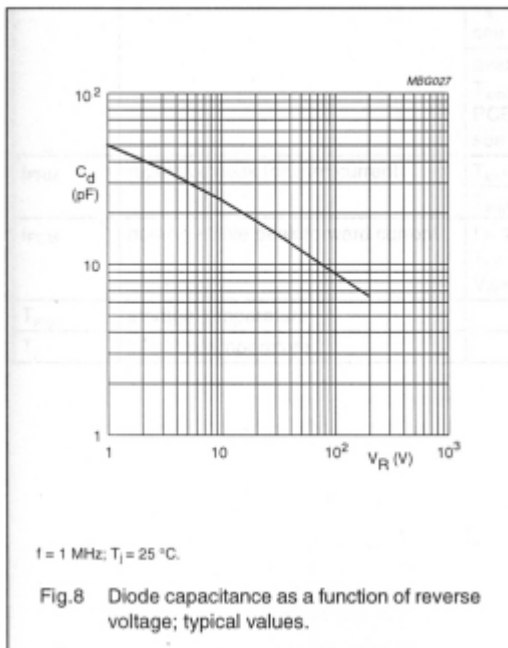
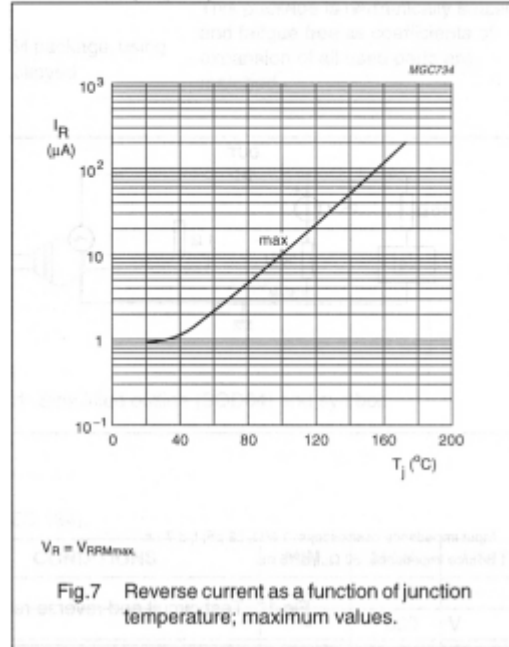
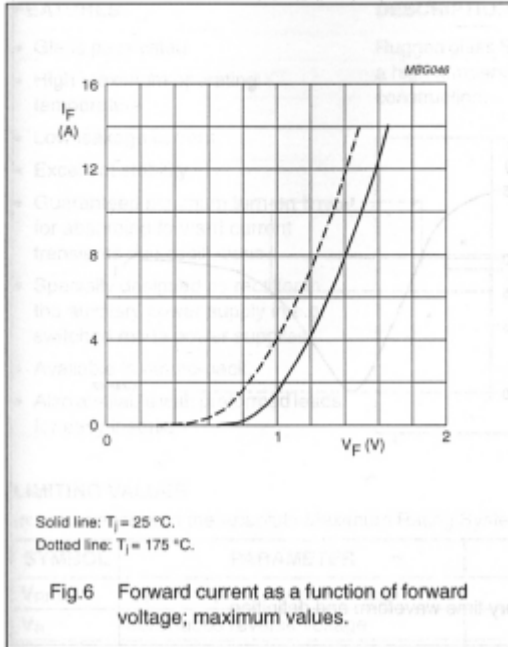

Controlled avalanche rectifiers

BYM56 series

