

Integrated Circuit

FA12201

low noise amplifier IC

6V / 300mW

DATASHEET

OEM –Mitsubishi

Source: Mitsubishi Databook 1989

MITSUBISHI SEMICONDUCTOR <GaAs FET>
FA12201
GaAs FET LOW NOISE AMPLIFIER MODULE

DESCRIPTION

The FA12201 is Low Noise, High Gain Amplifier Module used for the out door unit of 12 GHz DBS receiver.

This module is 2-stage low noise GaAs FET amplifier and operates only by controlling DRAIN current with GATE bias voltage.

FEATURES

- High Gain, Low noise
 $G_a = 18 \text{ dB (TYP.) @ } 11.7 \sim 12.2 \text{ GHz}$
 $NF = 2.2 \text{ dB (TYP.) @ } 11.7 \sim 12.2 \text{ GHz}$
- Low Power Dissipation
 $3\text{V}, 25 \text{ mA}$

APPLICATION

Out door unit of 12 GHz DBS receiver.

QUALITY GRADE

- GG

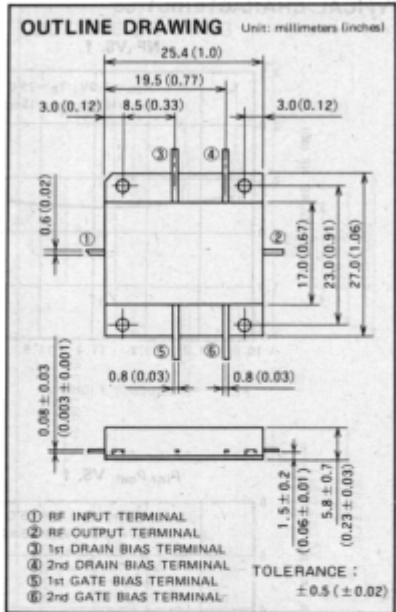

ABSOLUTE MAXIMUM RATINGS

Symbol	Parameter	Rating	Unit
V_{DD}	DC supply voltage (Note 1)	6	V
V_{GG}	GATE bias voltage (Note 2)	-6	V
I_D	Dissipation current	50	mA
P_{in}	Input power	-20	dBm
P_T	Total power dissipation (Note 3)	300	mW
T_{opr}	Operating temperature	-30 ~ +60	°C
T_{stg}	Storage temperature	-40 ~ +70	°C

Note 1. $V_{GG} = 0\text{V}$
 2. $V_{DD} = 0\text{V}$
 3. Maximum power dissipation per one GaAs FET is 150mW.

ELECTRICAL CHARACTERISTICS ($T_a = 25^\circ\text{C}$)

Symbol	Parameter	Test conditions	Limits			Unit
			Min	Typ	Max	
G_a	Gain	$V_{DD} = 3\text{V}, I_{D1} = 10\text{mA}, I_{D2} = 15\text{mA}$ $Z_0 = 50 \Omega, Z_L = 50 \Omega, f = 11.7 \sim 12.2 \text{ GHz}$	16	18		dB
NF	Noise figure			2.2	2.4	dB
P_{in}	Input VSWR			2.5	3.0	—
P_{out}	Output VSWR			2.3	2.5	—

I_{D1} : 1st stage DRAIN current I_{D2} : 2nd stage DRAIN current

MITSUBISHI SEMICONDUCTOR (GaAs FET)
FA12201

GaAs FET LOW NOISE AMPLIFIER MODULE

TYPICAL CHARACTERISTICS

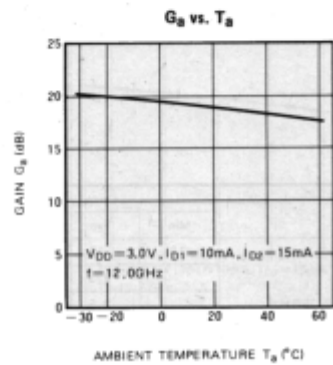
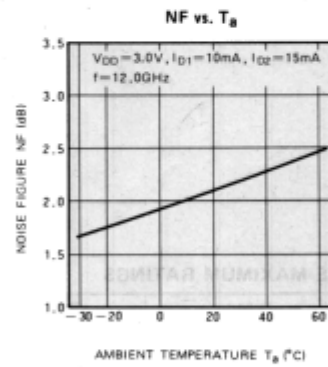
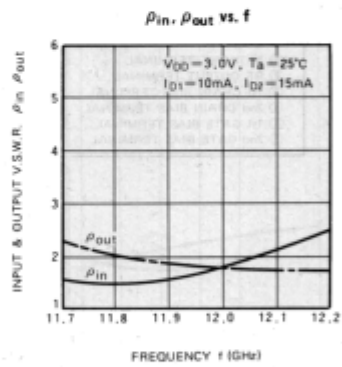
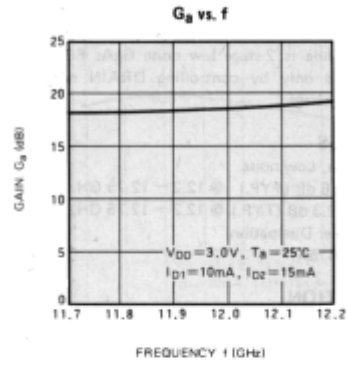
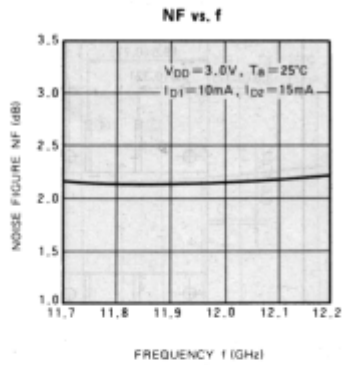

MITSUBISHI SEMICONDUCTOR <GaAs FET>
FA11 and 12 Series

GaAs FET LOW NOISE AMPLIFIER MODULE

EQUIVALENT CIRCUIT

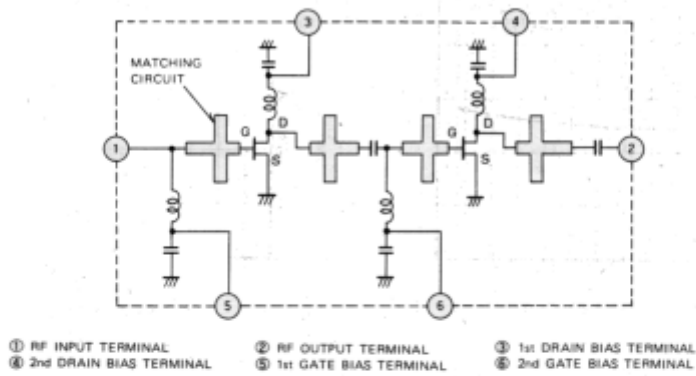

BIAS CIRCUIT

