

Silicon Diode

BY329X-1500S

1500V/6A

DATASHEET

OEM – Philips

Source: Philips Databook 1999

Damper diode fast, high-voltage

BY329X-1500, BY329X-1500S

FEATURES

- Low forward volt drop
- Fast switching
- Soft recovery characteristic
- High thermal cycling performance
- Isolated mounting tab

SYMBOL

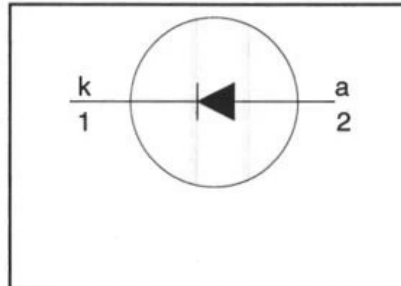

QUICK REFERENCE DATA

$V_R = 1500 \text{ V}$
$V_F \leq 1.35 \text{ V} / 1.5 \text{ V}$
$I_{F(\text{peak})} = 6 \text{ A} (f = 16 \text{ kHz})$
$I_{F(\text{peak})} = 6 \text{ A} (f = 70 \text{ kHz})$
$I_{\text{FSM}} \leq 75 \text{ A}$
$t_{\text{rr}} \leq 230 \text{ ns} / 160 \text{ ns}$

GENERAL DESCRIPTION

Glass-passivated double diffused rectifier diode featuring low forward voltage drop, fast reverse recovery and soft recovery characteristic. The device is intended for use in TV receivers and PC monitors.

The BY329X series is supplied in the conventional leaded SOD113 package.

PINNING

PIN	DESCRIPTION
1	cathode
2	anode
tab	isolated

SOD113

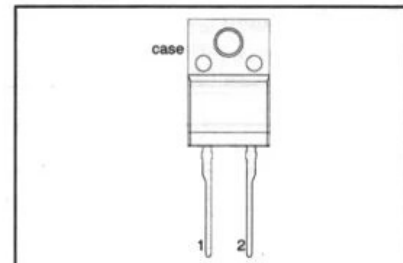

LIMITING VALUES

Limiting values in accordance with the Absolute Maximum System (IEC 134).

SYMBOL	PARAMETER	CONDITIONS	MIN.	MAX.	UNIT
V_{RSM}	Peak non-repetitive reverse voltage		-	1500	V
V_{RRM}	Peak repetitive reverse voltage		-	1500	V
V_{RWM}	Crest working reverse voltage		-	1300	V
$I_{\text{F}(\text{peak})}$	Peak working forward current	$f = 16 \text{ kHz}$	-	-1500	A
		$f = 70 \text{ kHz}$	-	-	A
I_{FRM}	Peak repetitive forward current	$t = 25 \mu\text{s}; \delta = 0.5; T_{\text{hs}} \leq 86 \text{ }^\circ\text{C}$	-	14	A
$I_{\text{F}(\text{RMS})}$	RMS forward current		-	11	A
I_{FSM}	Peak non-repetitive forward current	$t = 10 \text{ ms}$ sinusoidal; $T_{\text{j}} = 150 \text{ }^\circ\text{C}$ prior to surge; with reapplied $V_{\text{RWM}(\text{max})}$	-	75	A
T_{stg}	Storage temperature		-40	150	$^\circ\text{C}$
T_{j}	Operating junction temperature		-	150	$^\circ\text{C}$

Damper diode
fast, high-voltage

BY329X-1500, BY329X-1500S

ISOLATION LIMITING VALUE & CHARACTERISTIC

$T_{hs} = 25\text{ }^{\circ}\text{C}$ unless otherwise specified

SYMBOL	PARAMETER	CONDITIONS	MIN.	TYP.	MAX.	UNIT
V_{isol}	R.M.S. isolation voltage from both terminals to external heatsink	$f = 50\text{-}60\text{ Hz}$; sinusoidal waveform; $R.H. \leq 65\%$; clean and dustfree	-		2500	V
C_{isol}	Capacitance from both terminals to external heatsink	$f = 1\text{ MHz}$	-	10	-	pF

THERMAL RESISTANCES

SYMBOL	PARAMETER	CONDITIONS	MIN.	TYP.	MAX.	UNIT
$R_{th\ j-hs}$	Thermal resistance junction to heatsink	with heatsink compound	-	-	4.8	K/W
$R_{th\ j-a}$	Thermal resistance junction to ambient	without heatsink compound in free air.	-	55	5.9	K/W

STATIC CHARACTERISTICS

$T_j = 25\text{ }^{\circ}\text{C}$ unless otherwise stated

SYMBOL	PARAMETER	CONDITIONS	TYP.		MAX.		UNIT
			1500	1500S	1500	1500S	
V_F	Forward voltage	$I_F = 6.5\text{ A}$ $I_F = 6.5\text{ A}; T_j = 125\text{ }^{\circ}\text{C}$	1.1	1.3	1.45	1.6	V
I_R	Reverse current	$V_R = 1300\text{ V}$ $V_R = 1300\text{ V}; T_j = 125\text{ }^{\circ}\text{C}$	1.05	1.2	1.35	1.5	V
			-	250	-	250	μA
			-	1	-	1	mA

DYNAMIC CHARACTERISTICS

$T_j = 25\text{ }^{\circ}\text{C}$ unless otherwise stated

SYMBOL	PARAMETER	CONDITIONS	TYP.		MAX.		UNIT
			1500	1500S	1500	1500S	
t_{rr}	Reverse recovery time	$I_F = 1\text{ A}; V_R \geq 30\text{ V};$ $di_F/dt = 50\text{ A}/\mu\text{s}$	0.18	0.13	0.23	0.16	μs
Q_s	Reverse recovery charge	$I_F = 2\text{ A}; -di_F/dt = 20\text{ A}/\mu\text{s}$	1.6	0.7	2.0	0.95	μC
V_{tr}	Peak forward recovery voltage	$I_F = 6.5\text{ A}; di_F/dt = 50\text{ A}/\mu\text{s}$	17	23	30	40	V
t_{fr}	Forward recovery time	$I_F = 6.5\text{ A}; di_F/dt = 50\text{ A}/\mu\text{s}$	210	220	300	320	ns

Damper diode
fast, high-voltage

BY329X-1500, BY329X-1500S

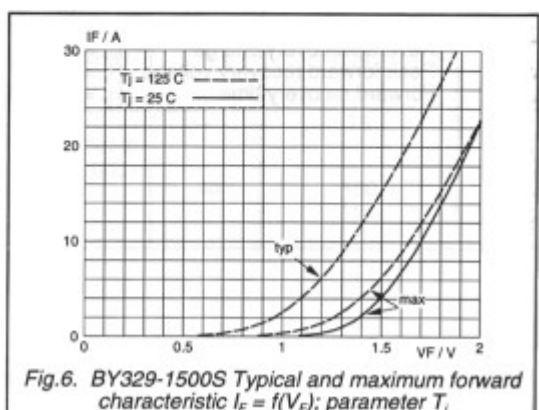
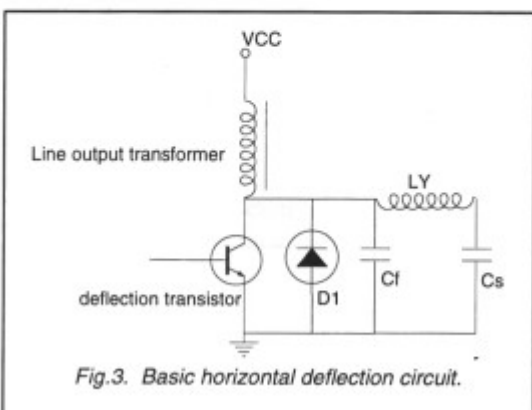
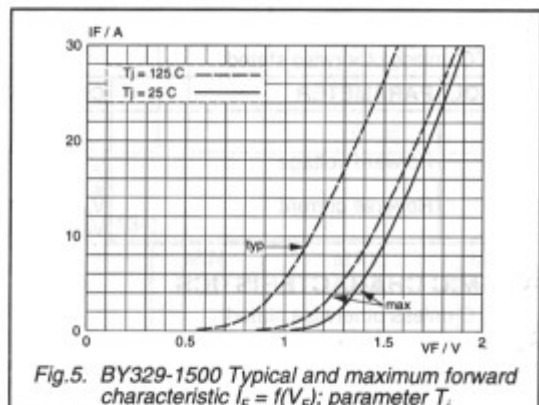
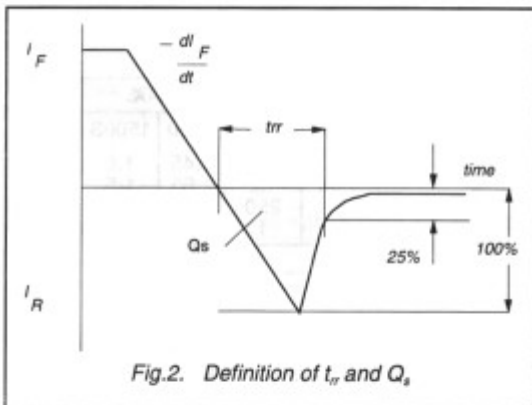
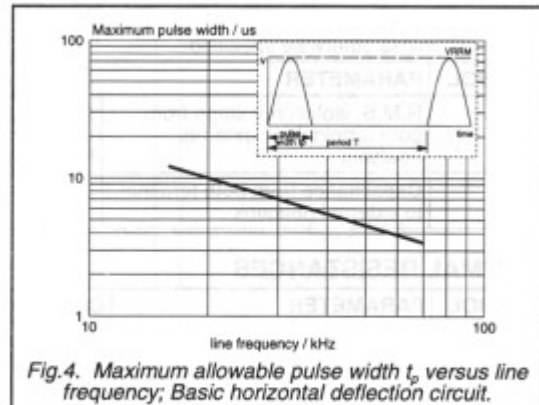
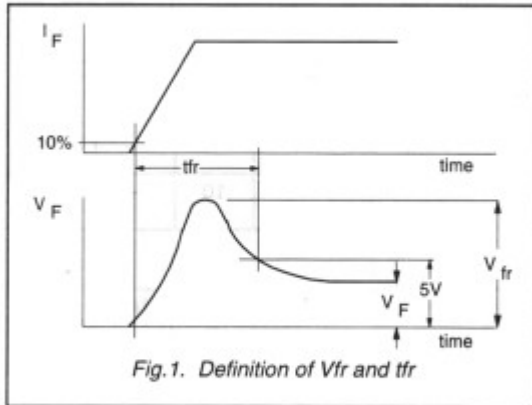

**Damper diode
fast, high-voltage**

BY329X-1500, BY329X-1500S

