

Silicon Diode

1N5616

400V / 1A

DATASHEET

OEM – Unitrode

Source: Unitrode Databook 1989-1990

RECTIFIERS

Standard Recovery, 1 Amp
Military Approved

1N5614, 1N5616, 1N5618,
1N5620, 1N5622
JAN, JANTX & JANTXV

FEATURES

- Qualified to MIL-S-19500/427
- PIV: to 1000V
- Controlled Avalanche

DESCRIPTION

This series of medium power general purpose rectifiers can be used in the most demanding military supplies. Rugged mechanical integrity and tight electrical parameters make them particularly useful.

ABSOLUTE MAXIMUM RATINGS

Peak Inverse Voltage	Type
200V	JAN, JANTX & JANTXV 1N5614
400V	JAN, JANTX & JANTXV 1N5616
600V	JAN, JANTX & JANTXV 1N5618
800V	JAN, JANTX & JANTXV 1N5620
1000V	JAN, JANTX & JANTXV 1N5622

Maximum Average D.C. Output Current

@ $T_A = 55^\circ\text{C}$ 1.0A
 @ $T_A = 100^\circ\text{C}$ 0.75A

Non-Repetitive Sinusoidal

Surge Current (8.3ms) 30A

Operating Temperature Range -65°C to $+175^\circ\text{C}$

Storage Temperature Range -65°C to $+200^\circ\text{C}$

Thermal Resistance θ_{JA} @ $L = \frac{3}{8}$ " 38°C/W

See Lead Temperature Derating Curve

MECHANICAL SPECIFICATIONS

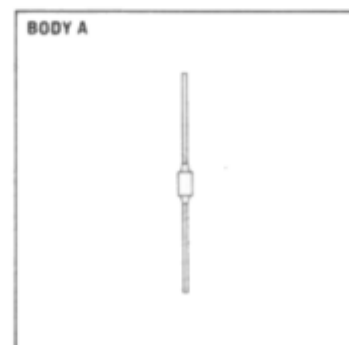
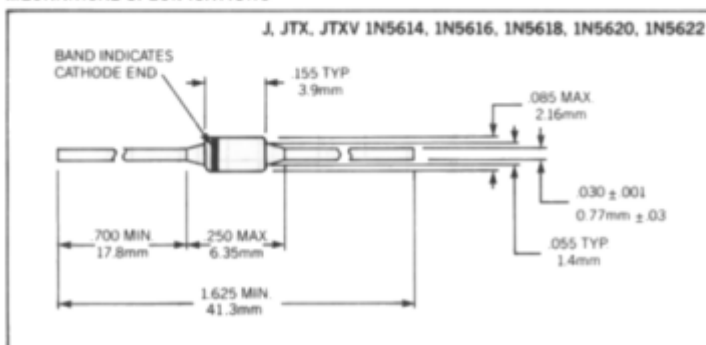

THESE DEVICES ALSO AVAILABLE IN SURFACE MOUNT PACKAGE. SEE SECTION 11.

JAN, JANTX, JANTXV 1N5614, 1N5616, 1N5618, 1N5620, 1N5622

ELECTRICAL SPECIFICATIONS (at 25°C unless noted)

Type	PIV	Minimum Reverse Breakdown Voltage @ 50 μ A	Forward Voltage		Maximum Reverse Current		Maximum Reverse Recovery Time*
			Min.	Max.	25°C	100°C	
J, JTX, JTXV 1N5614	200V	220V	0.8	1.3V(pk) @ 3.0A tp = 300 μ S	0.5 μ A	25 μ A	2.0 μ S
J, JTX, JTXV 1N5616	400V	440V					
J, JTX, JTXV 1N5618	600V	660V					
J, JTX, JTXV 1N5620	800V	880V					
J, JTX, JTXV 1N5622	1000V	1100V					

*Measured in Circuit $I_f = 1/2A$, $I_R = 1.0A$, $I_{REC} = 1/4A$

